



EL-WEM

WiFi Indoor Air Quality Monitor

Your data, anytime, anywhere

- Records Indoor Air Quality (IAQ) with alarms
- Measures:
 - Particulate Matter
 - Temperature
 - Humidity
 - VOC's
 - Pressure
- Automatically uploads data to the EasyLog Cloud
- Coloured status ring shows IAQ level
- Audible and visual alert with email and SMS notifications available
- Detects VOCs from paints, lacquers, paint strippers, cleaning products, furnishings, glues, adhesives and alcohol
- Control multiple devices and view data anywhere with EasyLog Cloud and App
- Power supply included
- Internal back-up battery if power interrupted



The EL-WEM continually monitors Indoor Air Quality, with a coloured status ring to display the IAQ level at a glance. It also automatically uploads data to the EasyLog Cloud, allowing your complete set of data measurements to be viewed, analysed and downloaded from any internet-enabled device.

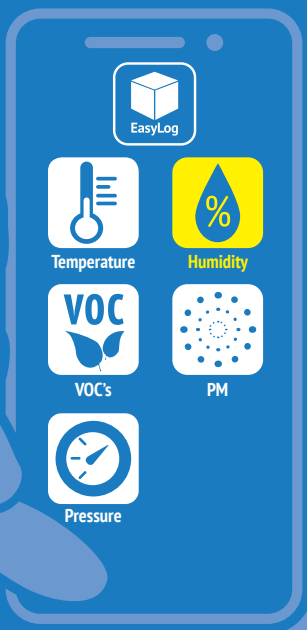

The IAQ level is rated in five levels from Excellent to Inadequate, and if it reaches either of the two lowest levels the status ring turns red. Using the EasyLog Cloud, you can set emails and SMS messages to notify you as soon as this happens. You can also activate an audible alert sounder, and set a daily Do Not Disturb period if you wish.

The EL-WEM is simple to set up, with a single button press and the EasyLog Cloud App.

A power supply is included and the unit also has an internal back-up battery, allowing it to continue operating in low power mode if mains power is temporarily lost.



The status ring indicates the current IAQ level at a glance



EasyLog

Your data, anytime, anywhere

EL-WEM

WiFi Indoor Air Quality Monitor

What Contributes to Indoor Air Quality?

Air quality is a key contributor to feeling comfortable, and staying healthy, at work and in the home. The EL-WEM uses a silent fan to sample the air around it, the internal sensors measuring five important factors.



Particulate Matter (PM)

Tiny particles that hang in the air include pollen, dust, mould spores and soot from engines and fires. In high concentrations these can cause allergic reactions and health problems. The EL-WEM measures two types: PM10 and the extremely small PM2.5.

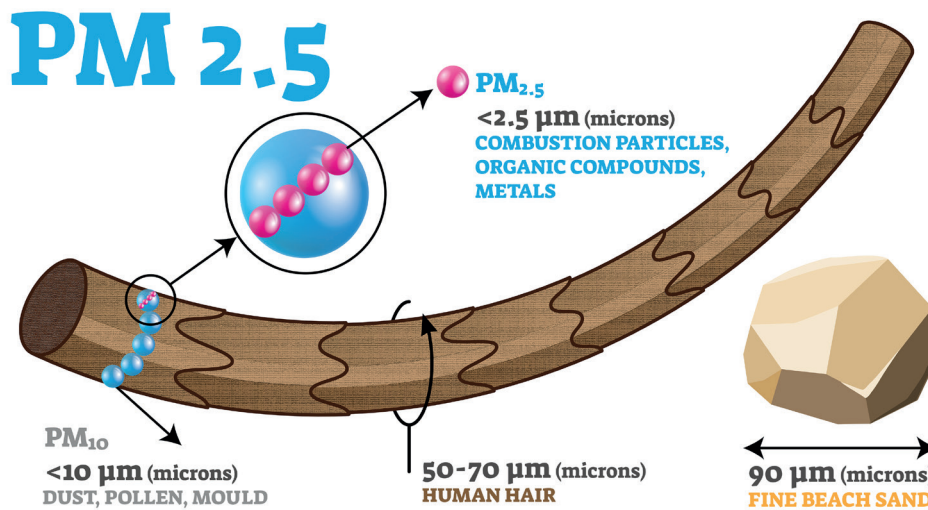

How Can I Improve Indoor Air Quality?

The easiest and most important way is to open windows to allow fresh air in, and also to encourage air circulation by opening any internal doors. Also use fans and ventilators where available, and keep rooms clean and free of dust and pet hair. Remove sources of pollutants such as chemicals and cleaning products, and make sure all sources of combustion emissions (such as boilers and cookers) are clean and well maintained. Air conditioning systems and dehumidifiers can help keep both the temperature and humidity within comfortable limits.

Temperature

Our bodies immediately sense if we are too hot or too cold, but temperature changes can also cause physical reactions that affect our susceptibility to viruses and other airborne diseases. Poor temperatures can also accelerate the growth of mould and bacteria on indoor surfaces.

Humidity

The amount of moisture in the air can affect how well our bodies can maintain a comfortable internal temperature. Low levels can lead to irritated skin and eyes, and high humidity can stimulate mould growth.

Volatile Organic Compounds (VOC's)

VOC's are gases and chemicals in the air that can have health effects. Many common chemicals and materials emit VOCs, sometimes over long periods of time. These include paint and varnishes, cleaning products and air fresheners, plastics, fabrics and many more.

Air Pressure

High atmospheric pressure can exacerbate joint pain and contribute to headaches and migraines. It can also have an effect on blood pressure and blood sugar levels.



EasyLog

Your data, anytime, anywhere

EL-WEM

WiFi Indoor Air Quality Monitor

IAQ RATING INDEX

Indoor Air Quality is scored out of 20, by adding together scores out of 5 for four measured parameters. The total score determines the IAQ rating, on five levels, from Excellent down to Inadequate. The status ring colour on your EL-WEM matches the IAQ rating.

IAQ Rating	Excellent	Good	Fair	Poor	Inadequate
IAQ Score	≥ 18 points	≥ 16 points	≥ 12 points	≥ 8 points	< 8 points

The IAQ score is calculated as follows:

	Temperature °C	Humidity % RH	VOC Index	PM10 µg/m ³
5 points	18 ≤ T ≤ 21	40 ≤ RH ≤ 60	VOC < 50	PM < 33
4 points	17 ≤ T < 18 21 < T ≤ 22	30 ≤ RH < 40 60 < RH ≤ 70	51 ≤ VOC < 100	33 ≤ PM < 58
3 points	16 ≤ T < 17 22 < T ≤ 23	20 ≤ RH < 30 70 < RH ≤ 80	101 ≤ VOC < 150	58 ≤ PM < 75
2 points	15 ≤ T < 16 23 < T ≤ 24	10 ≤ RH < 20 80 < RH ≤ 90	151 ≤ VOC < 200	75 ≤ PM < 91
1 point	T < 15 T > 24	RH < 10 RH > 90	VOC ≥ 201	PM ≥ 91

- Example: Temperature 10°C (1 point), Humidity 9% (1 point), VOC 220 (1 point), PM10 96 (1 point) = 4 points total, IAQ rating is Inadequate.
- You can find a copy of this table, including Temperature in °F, by clicking the ? help icon next to the measurement readings in the EasyLog Cloud.

CONNECTING TO THE CLOUD



1

Plug in the power supply, then press the central button to turn the device on.



2

Download and login to the EasyLog Cloud App on your mobile device. Select "Setup Device" and follow the on-screen instructions to add your EL-WEM.



3

You can now view the EL-WEM's data and change settings either in the EasyLog Cloud App or by visiting your account at: www.easylogcloud.com



EasyLog

Your data, anytime, anywhere

EL-WEM

WiFi Indoor Air Quality Monitor

EasyLog Cloud *Your Data: Anytime. Anywhere.*



Easily access your most important data, anywhere



Connect data loggers from multiple sites in one account



Automatic emails alerts and SMS



Remotely manage all of your data logger devices



Graph, review and analyse your data



Audits are easy with our event log system



Secure Cloud storage



Configurable user profiles

EasyLog Cloud App

Available for Android and Apple devices, the EasyLog Cloud app enables you to monitor and manage your wireless sensors on the go.

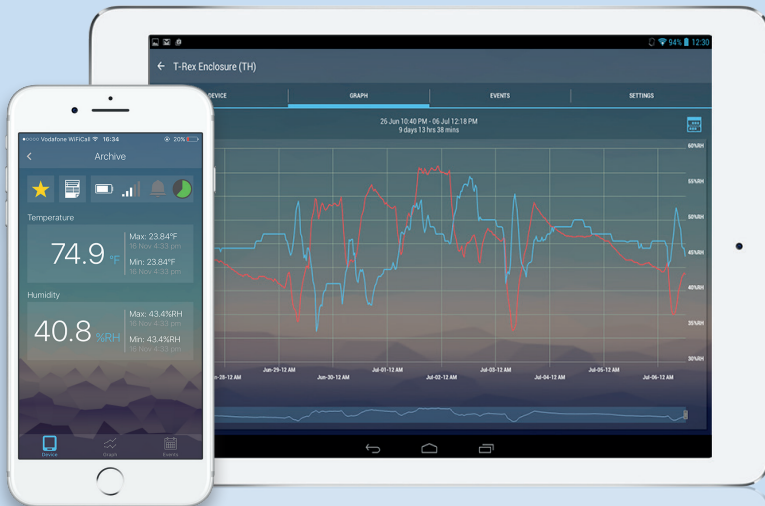

Access your vital data from any internet-enabled computer, tablet or mobile device with EasyLog Cloud. From single locations to worldwide operations, the system is perfectly scalable and can run through your existing wireless networks.

Critical events are notified to specific users in seconds via an alarm system that's easily tailored to your exact requirements.

Data is accessible 24/7 and powerful online tools make it simpler than ever to view, compare and analyse readings. An audit trail is automatically created that includes both system and data events.

Starter and Professional accounts are available, always flexible and with no locked-in contracts.

www.lascarelectronics.com





EasyLog

Your data, anytime, anywhere

EL-WEM

WiFi Indoor Air Quality Monitor

INCLUDED IN THE BOX



EL-WEM



PSU
Power supply



3 x ADAPTORS



CABLE
Power cable

ALSO IN THE RANGE

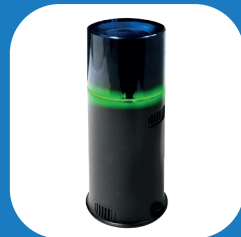

EL-WEM+

DIMENSIONS

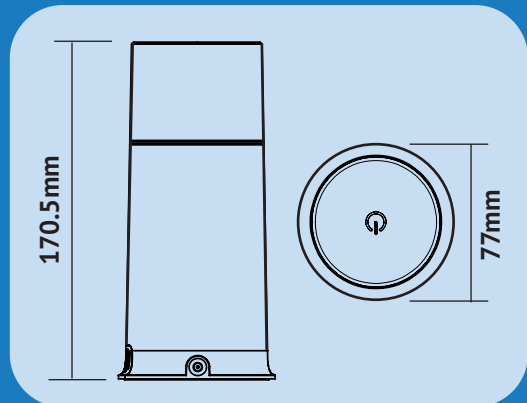

SPECIFICATIONS



Particulate Matter	
Measured Categories	PM2.5, PM10
Temperature	
Measurement Range	-20 to +60°C
Resolution	0.1°C
Measurement Accuracy	±0.6°C at 15°C
Humidity	
Measurement Range	0 to 95%RH
Resolution	1%RH
Measurement Accuracy	±3%
Volatile Organic Compounds (VOC)	
Biogenic VOC Accuracy	±5%
Pressure	
Measurement Range	300 to 1100mbar
Measurement Accuracy	±0.6mbar
Dimensions	
Height x Diameter	170.5 x 77mm

 The appliance can be used by children from 8 years and above and persons with reduced physical, sensory or mental capabilities or lack of experience and knowledge if they have given supervision or instruction concerning use of the appliance in a safe way and understand the hazards involved. Children shall not play with the appliance. Cleaning and user maintenance shall not be made by children without supervision. This appliance must only be supplied at safety extra low voltage corresponding to the marking on the appliance. This appliance contains batteries that are only replaceable by skilled persons. **WARNING:** For the purpose of recharging the battery, only use the power supply model: ICP06C-050-1000B provided with this appliance.

 ICP06C-050-1000B



Visit lascarelectronics.com/data-loggers to see our full range of data loggers and measuring devices

www.lascarelectronics.com

